

VIEW	TOLERANCE	
	0-10	±1
	11-250	±5
	251-500	±10
	501-1000	±20
UNIT: mm	1001-3000	±50
	3001-5000	±100
	5001- >	±150

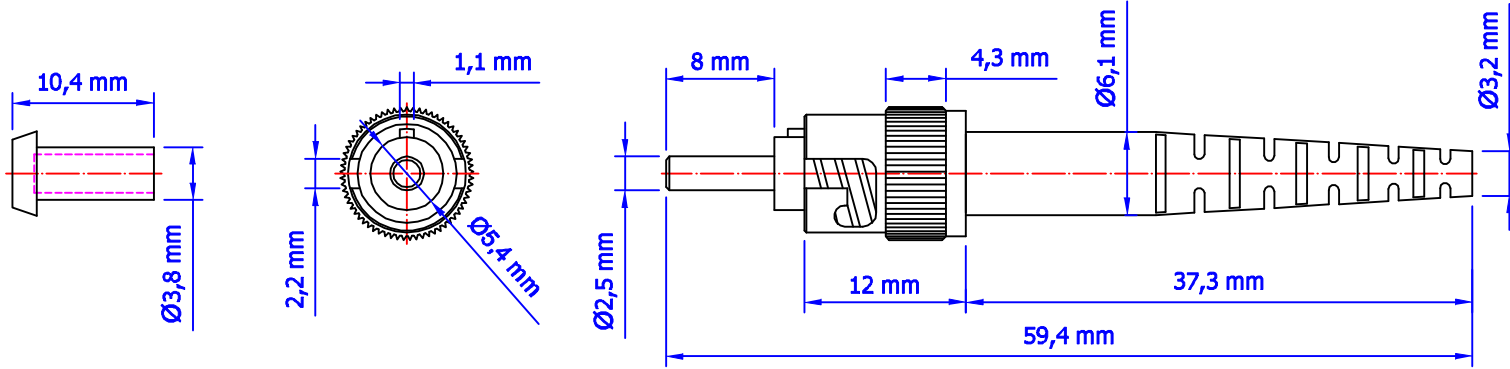

Date	16.03.2016	Rev.	-	Revision Detail		Rev.Dt.		Rev.by		Part No		
Designed by	Yeşim AKSOY									ST/PC SM SX CONNECTOR		
Checked by	Mevlüt GÜRBÜZ											
										Drawing Nr.	Scale	Sheet No
										FO-0301SMP412	NONE	1/1